

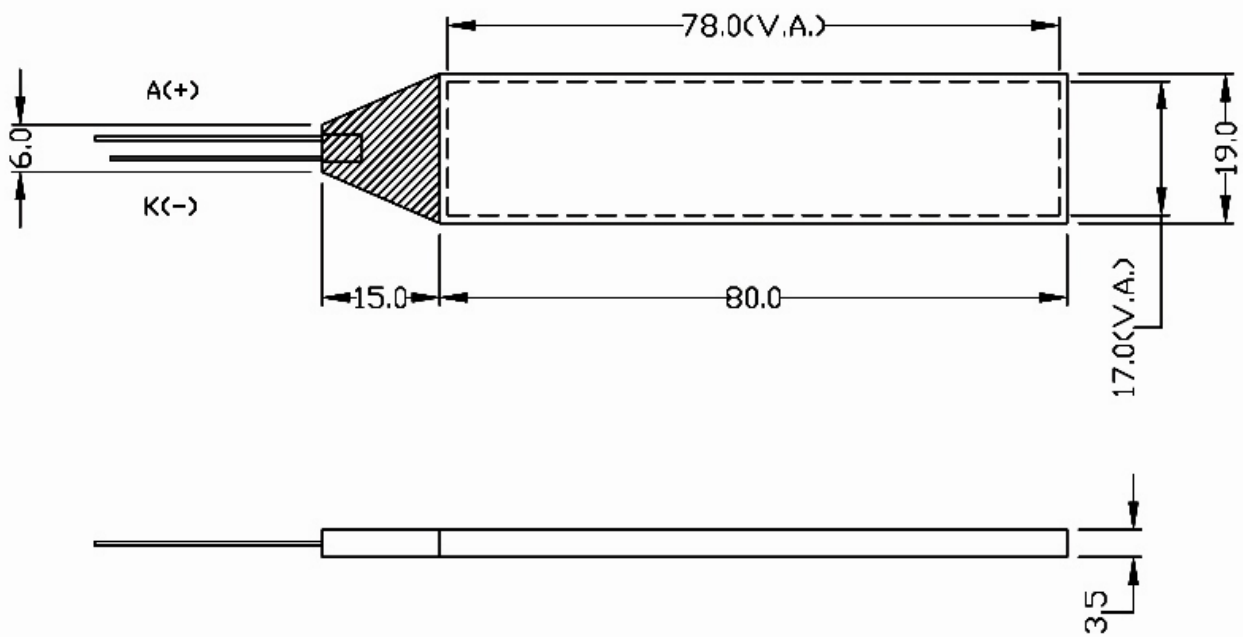

**LP-95-19**

**LED Back Light**



**Outline Drawing Unit : mm**

**Characteristics :**

Model No.	Color	Wave Length $\lambda$ (nm)	Forward Voltage (V)
LP-95-19-BE	Blue	465 -470	3.2 - 3.6
LP-95-19-GN	Green	520 - 525	3.1 - 3.5